

User's Manual

Version 1.1 June 2002

ENGLISH



AUTOCOM PRO-XL MDX1600



COMPOSER PRO-XL MDX2600



MULTICOM PRO-XL MDX4600



SAFETY INSTRUCTIONS



CAUTION: To reduce the risk of electric shock, do not remove the top cover (or the rear section). No user serviceable parts inside; refer servicing to qualified personnel.

WARNING: To reduce the risk of fire or electric shock, do not expose this appliance to rain and moisture.



This symbol, wherever it appears, alerts you to the presence of uninsulated dangerous voltage inside the enclosure—voltage that may be sufficient to constitute a risk of shock.



This symbol, wherever it appears, alerts you to important operating and maintenance instructions in the accompanying literature. Please read the manual.

DETAILED SAFETY INSTRUCTIONS:

All the safety and operation instructions should be read before the appliance is operated.

Retain Instructions:

The safety and operating instructions should be retained for future reference.

Heed Warnings:

All warnings on the appliance and in the operating instructions should be adhered to.

Follow instructions:

All operation and user instructions should be followed.

Water and Moisture:

The appliance should not be used near water (e.g. near a bathtub, washbowl, kitchen sink, laundry tub, in a wet basement, near a swimming pool etc.).

Ventilation:

The appliance should be situated so that its location or position does not interfere with its proper ventilation. For example, the appliance should not be placed on a bed, sofa, rug, or similar surface that may block the ventilation openings, or placed in a built-in installation, such as a bookcase or cabinet that may impede the flow of air through the ventilation openings.

Heat:

The appliance should be situated away from heat sources such as radiators, heat registers, stoves, or other appliances (including amplifiers) that produce heat.

Power Source:

The appliance should be connected to a power supply only of the type described in the operating instructions or as marked on the appliance.

Grounding or Polarization:

This device must be grounded.

Power-Cord Protection:

Power supply cords should be routed so that they are not likely to be walked on or pinched by items placed upon or against them, paying particular attention to cords and plugs, extension cords and the point where they exit from the appliance.

Cleaning:

The appliance should be cleaned only as recommended by the manufacturer.

Non-use Periods:

The power cord of the appliance should be unplugged from the outlet when left unused for extended periods of time.

Debris and Liquid Entry:

Care should be taken that debris and/or liquids do not enter the enclosure through openings.

Damage Requiring Service:

The appliance should be serviced by qualified service personnel when:

- ▲ The power supply cord or the plug has been damaged; or
- ▲ Debris or liquid has entered the appliance; or
- ▲ The appliance has been exposed to rain; or
- ▲ The appliance does not appear to operate normally or exhibits a noticeable change in performance; or
- ▲ The appliance has been dropped, or the enclosure damaged.

Service:

The user should not attempt to service the appliance beyond that which is described in the operating instructions. All other servicing should be referred to qualified service personnel.

FOREWORD

Dear Customer,

welcome to the team of BEHRINGER users and thank you very much for expressing your confidence in us by purchasing this unit. It is one of my most pleasant tasks to write this letter to you, because it is the culmination of many months of hard work delivered by our engineering team to reach a very ambitious goal: Shaping a new generation of dynamic processors that suit all possible demands of dynamic processing—be it in the studio or under the most demanding live conditions.

The COMPOSER PRO, the AUTOCOM PRO and the MULTICOM PRO have for quite a long time been standard tools used by numerous studios and PA rental companies. The task to improve some of our best-selling products certainly meant a great deal of responsibility, which we assumed by focusing on you, the discerning user and musician. It also meant a lot of work and night shifts to accomplish this goal. But it was fun, too. Developing products usually brings a lot of people together, and what a great feeling it is when everybody who participated in such a project can be proud of what we've achieved.

It is our philosophy to share our joy with you, because you are the most important member of the BEHRINGER family. With your highly competent suggestions for new products you've greatly contributed to shaping our company and making it successful. In return, we guarantee you uncompromising quality (manufactured under ISO9000 certified management system) as well as excellent technical and audio properties at an extremely competitive price. All of this will enable you to fully unfold your creativity without being hampered by budget constraints.

We are often asked how we can produce such high-grade devices at such unbelievably low prices. The answer is quite simple: it's you, our customers! Many satisfied customers mean large sales volumes enabling us to get better conditions of purchase for components etc. Isn't it only fair to pass these benefits back to you? Because we know that your success is our success, too!

I would like to thank all people whose help on the projects COMPOSER PRO-XL, AUTOCOM PRO-XL and MULTICOM PRO-XL has made it all possible. Everybody has made very personal contributions, starting from the designers of the unit to the many staff members in my company to you, the user of BEHRINGER products.

My friends, it's been worth the trouble!

Thank you very much,



Uli Behringer

TABLE OF CONTENTS

1. INTRODUCTION 3

 1.1 Before you get started 4

 1.1.1 Shipment 4

 1.1.2 Initial operation 4

 1.1.3 Warranty 5

 1.2 The user's manual 5

2. CONTROL ELEMENTS AND CONNECTORS 5

 2.1 The expander/gate section 5

 2.2 The compressor section 6

 2.3 The dynamic enhancer section 7

 2.4 The de-esser section 7

 2.5 The peak limiter section 7

 2.6 The rear panel control elements 8

3. EXAMPLES OF SIDCHAIN APPLICATIONS 8

 3.1 Eliminating interference 8

 3.2 Emphasizing instruments 9

 3.3 Time-delayed compression 9

 3.4 "Voice over" compression ("ducking") 9

 3.5 Triggering additional sounds from a rhythm track 9

4. WIRING 9

5. INSTALLATION 10

 5.1 Rack installation 10

 5.2 Audio connections 10

6. SPECIFICATIONS 11

7. WARRANTY 12

1. INTRODUCTION

With this new dynamics processor from the PRO-XL series you have acquired an extremely powerful and universal compressor which unites in one compact device all of those dynamics control functions that are most frequently used in practice: each channel has an independent compressor/limiter, expander/gate and peak limiter. Thus, virtually all dynamics processing problems can be remedied with little effort.

Future-oriented BEHRINGER technology

The new PRO-XL dynamics processors from BEHRINGER feature several innovative circuit designs, making them top-class dynamics processing equipment. Compared to their predecessors, they now have improvements such as the de-esser, which allows you to effectively suppress disturbing hiss noise (COMPOSER PRO-XL), additional LED displays to set the de-esser levels, plus a switchable enhancer.

The AUTOCOM PRO-XL not only includes an enhancer, but also a switchable de-esser and a peak limiter, which has already proved its versatility in the COMPOSER PRO.

The BEHRINGER MULTICOM PRO-XL has been upgraded with an expander/noise gate plus enhancer. Additionally, we have managed to improve its audio properties even further—in combination with a revised circuit design.

To give you the best operational reliability possible, we manufacture our products in accordance with the highest quality standards known in the industry. Additionally the dynamic processors are manufactured under ISO9000 certified management system.



VAD (Voice-Adaptive) De-esser

The COMPOSER PRO-XL and AUTOCOM PRO-XL incorporate a newly designed de-esser circuit specifically adapted to process the critical range of treble frequencies. Hiss noise on vocal tracks often contains high levels, giving the signals a rather edgy, unpleasant sound. The de-esser responds to those frequency ranges in which hiss noise usually occurs and limits the overall signal level as soon as the audio signal is affected by excessive energy density in this range. Unlike equalizers, however, it does not impair the frequency response of the signal. In this way, intelligibility in low-level passages is perfectly preserved, and you can even boost the treble range with a good equalizer. The sound becomes transparent and fresh, while the de-esser prevents hiss noise from becoming too dominant and disturbing the overall sound image.



IDE (Interactive Dynamic) Enhancer

Probably the best known negative side effect of a compressor is the “dull” and “compressed” sound that is likely to result from the processing of complex program material. Low-frequency instruments usually produce the highest signal energy and hence make the compressor reduce the overall level. Any instrument in the higher frequency ranges concurrently played also has its level reduced, which leads to a “compressed” overall sound.

The dynamic enhancer provides the solution to this problem, enabling you to make up specifically for the compression-induced loss of treble energy. Since the enhancer can detect the amount of compression applied, it does not change the sound image as long as the signals remain uncompressed. No treble energy is lost, even when complex mix-down material is processed.



ATS (Authentic Tube Simulation) circuitry

Even today, the warm, expressive and transparent tonal character of electronic tubes is a real “classic”. We proudly present the COMPOSER PRO-XL and its high-tech circuit design enabling the authentic reproduction of this legendary sound, and at the same time avoiding all of the technical drawbacks that go along with tube technology. Owing to state-of-the-art semi-conductor technology, there is no sound deterioration caused by tube ageing, there are no heat problems and no maintenance required at all. All that remains is the advantage of tube technology: its distinctive sound!



IKA (Interactive Knee Adaptation) Compressor

Our proven IKA (Interactive Knee Adaptation) circuit successfully combines the “hard knee” compressor concept with the “soft knee” characteristic. This program-dependent control characteristic makes it possible to both provide an “inaudible” and musical program compression and allows for creative and efficient dynamics processing.



IRC (Interactive Ratio Control) Expander

A fundamental problem when using a compressor is the fact that the basic noise floor depends on the amount of compression applied, i.e. it is amplified maximally in low-level passages and breaks in the music (compressor noise). To eliminate this problem, compressors are usually equipped with additional expander or gate circuitry, simply fading out the noise during breaks.

The dynamics processors from the PRO-XL Series feature our IRC (Interactive Ratio Control) expander, whose ratio setting changes automatically with the program material. The result is an expander that can be set quickly and easily, and does not cut off low-level wanted signals (e.g. the first or last syllable of a word in a vocal track). With the new IRC circuit, the expander/gate section of the BEHRINGER COMPOSER PRO-XL MDX2600, AUTOCOM PRO-XL MDX1600 and MULTICOM PRO-XL MDX4600 can be used as an independent device to eliminate any kind of interference, thus giving you almost unlimited flexibility of application.



IGC (Interactive Gain Control) Peak Limiter

Another outstanding feature of BEHRINGER dynamics processors is the IGC (Interactive Gain Control) limiter, an intelligent combination of a clipper and program limiter. The clipper comes in as soon as an adjustable threshold is exceeded and abruptly limits the signal gain. However, if the limiter threshold is exceeded for longer than a few milliseconds, the IGC circuit is activated automatically and reduces the gain of the overall output signal, so that audible distortion is eliminated (program limiter). When the signal drops below threshold again, its level is restored to its original value after about one second. This IGC feature is an extremely useful tool for both live applications (e.g. speaker protection) and digital processing, in which excess levels lead to unpleasant distortion.

Safety relay

The design of the COMPOSER PRO-XL incorporates the so-called safety relays, which set the unit to bypass in case of a power failure or other malfunctions. Additionally, these relays are used to implement a switch-on delay, so as to suppress harmful switch-on thumps.

Balanced inputs and outputs

The BEHRINGER dynamics processors from the PRO-XL series are equipped with electronically balanced inputs and outputs. The automatic servo function detects any unbalanced plugs connected and adjusts the nominal level internally, so as to make sure that there is no difference in level between the input and output signals (6-dB correction).

First, this manual describes the terminology used, so that you understand the unit and its functions. Please read the manual carefully and keep it for future reference.

1.1 Before you get started

1.1.1 Shipment

Your COMPOSER PRO-XL, AUTOCOM PRO-XL or MULTICOM PRO-XL was carefully packed at the factory and the packaging is designed to protect the unit from rough handling. Nevertheless, we recommend that you carefully examine the packaging and its contents for any signs of physical damage which may have occurred during transit.

If the unit is damaged, please do NOT return it to BEHRINGER, but notify your dealer and the shipping company immediately. Otherwise, claims for damage or replacement may not be granted.

1.1.2 Initial operation

Be sure that there is enough space around the unit for cooling and, to avoid overheating, please do not place it on power amplifiers, near radiators etc.

Before you connect the unit to the mains, please make sure that the voltage setting on the unit matches the local voltage:

The fuse holder at the AC power connector has 3 triangular markings. Two of these three triangles are aligned with one another. The unit is set to the voltage shown next to these markings and can be switched over by turning the fuse holder by 180°. **IMPORTANT: This does not apply to export models designed exclusively for 115 V operation!**

If you set the unit to a different mains voltage, be sure to use a fuse of the correct type and rating. Please refer to the “SPECIFICATIONS” for details.

Blown fuses must be replaced by fuses of the same type and rating! Please refer to the “SPECIFICATIONS” for details.

The mains connection is made using the enclosed power cord and a standard IEC receptacle. It meets all of the international safety certification requirements.

Please make sure that all units have a proper ground connection. For your own safety, never remove or disable the ground conductor from the unit or of the AC power cord.

1.1.3 Warranty

Please take the time to fill in and return the warranty card within 14 days after the date of purchase, so as to benefit from our extended warranty. The serial number is printed on the top side of the unit. Or register online at www.behringer.com.

1.2 The user's manual

This manual has been designed to give you a survey of all control elements and at the same time provide you with detailed information on how to use them. To help you understand what each control does, we have grouped the control elements according to function. If you need more detailed information on specific topics, please visit our website at www.behringer.com, where you will find for example explanations of in-detail dynamics applications.

2. CONTROL ELEMENTS AND CONNECTORS

This chapter describes the various control elements of your dynamics processor. All controls are explained in full detail, including useful suggestions on how to use them.

The COMPOSER PRO-XL and AUTOCOM PRO-XL feature two identical channels, the MULTICOM PRO-XL four of them.

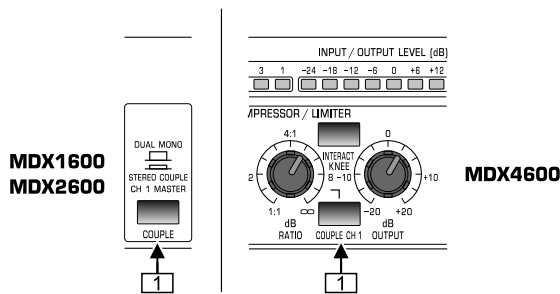

Fig. 2.1: Linking channels with the COUPLE switch

- 1 Pressing the COUPLE switch links the channels. In couple mode, dynamics are controlled by using channel 1 switches and controls, whereby the control signal is derived from the energy of both side chain channels (true stereo processing). Therefore, all switches and controls of channel 2 (except for IN/OUT, SC EXT, SC MON, LO CONTOUR, TUBE, DE-ESSER, MALE, ENHANCER, I/O METER switches and OUTPUT, DE-ESSER LEVEL and ENHANCER LEVEL controls) will be disabled when you activate the COUPLE switch. On the MDX4600, channel 3 controls channel 4 in link mode.

2.1 The expander/gate section

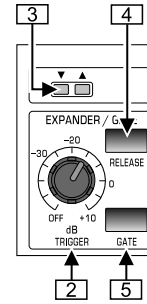

Fig. 2.2: Expander/gate section control elements

- 2 Use the TRIGGER control in the expander/gate section to determine the threshold **below** which expansion sets in, so that signals below threshold are reduced in gain. The setting range is from OFF to +10 dB.
- 3 If a signal below the adjusted value is applied, the red LED (expansion on) lights up. If the signal gain is above the adjusted value, the green LED lights up.
- 4 In order to adapt the expander/gate optimally to the program material, use the RELEASE switch to select a short or long release time. Percussive material with little or no reverb at all is usually processed with a short release time (switch not pressed). The long release time is the best choice for slowly decaying or heavily reverberated signals (switch pressed).
- 5 The GATE switch allows you to toggle between the expander (switch not pressed) and the gate function (switch pressed). Use the gate function to mute signals below threshold (e.g. noise).

Application hints

The purpose of using an expander is usually to expand the usable dynamics towards the lower end, i.e. to improve the separation between low-level signals and the unavoidable noise floor by reducing the noise level.

Start setting up the expander by turning the TRIGGER control from position OFF clockwise until the LEDs show the onset of the gain reduction. Preferably, you should use some music material containing pauses and soft passages, so as to hear whether the beginnings or endings of words are cut off by the expander or are suppressed too much. If necessary, experiment with the release time or reduce the threshold a little bit.

Gates work basically in the same way, the major difference being the fact that they reduce gain to a much greater extent. Once the level drops below threshold, the signal is muted completely.

The classic application of a gate is the separation of signals delivered by multiple microphones in a multitrack recording. Especially when drums are recorded, a gate is almost indispensable to avoid crosstalk, e.g. of the cymbals into the floor tom microphones.

However, you should always try to use the microphones and their directivity in the first place to achieve some degree of channel separation and hence a better and more natural result. Subsequently, a gate helps you optimize your set-up.

The program-dependent IRC allows you to set both gate and expander easily and conveniently. Nevertheless, you should experiment with different release times and trigger settings to get a perfect result!

2.2 The compressor section

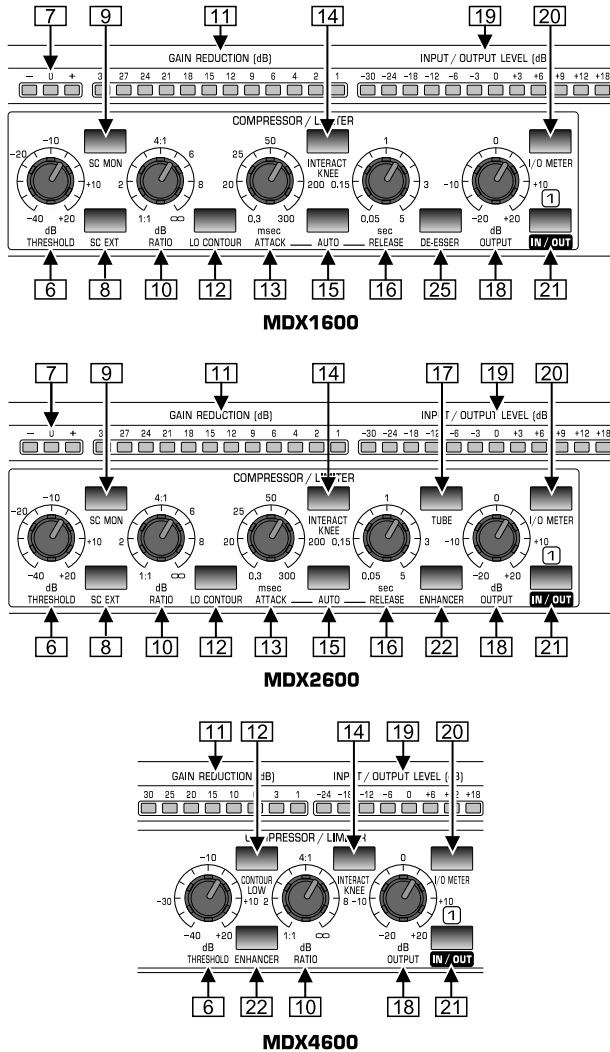

Fig. 2.3: Compressor section control elements

- 6 Use the **THRESHOLD** control to adjust the compressor threshold from -40 to +20 dB.
 - 7 These three LEDs (AUTOCOM PRO-XL and COMPOSER PRO-XL only) indicate whether the input signal is above or below the adjusted compressor threshold. The yellow LED in the middle refers to the IKA “soft knee” range (if IKA is on).
 - 8 Activating the **SC EXT** switch interrupts the link between the signal input and the compressor control section. At the same time, an external control signal can be fed in via the rear panel SC RETURN jack, taking over control of the input signal dynamics reduction. You can, for example, intensify the control function in a specific frequency range by inserting an equalizer via the SC SEND AND SC RETURN jacks. Detailed information on this special application can be found in chapter 3 “EXAMPLES OF SIDECHEIN APPLICATIONS”. This function, too, is only available on the AUTOCOM PRO-XL and COMPOSER PRO-XL.
 - 9 The **SC MON** switch links the sidechain input signal to the audio output, thereby muting the audio input signal. For example, this allows you to pre-monitor the sidechain signal in combination with an equalizer or other device inserted into the sidechain channel. The SC MONITOR function makes it easier to for example adapt the equalizer filters to the control signal.
- With the **SC MONITOR** switch activated, only the side-chain signal will be present at the output, which is shown by the flashing LED switch!

- 10 The **RATIO** control determines the ratio of input vs. output level with regard to all signals exceeding threshold by more than 10 dB. Although the compression starts earlier, the IKA characteristic ensures the smooth, inaudible onset of the gain reduction, which is why the ratio value will be reached only with 10 dB or more above threshold. It can be set continuously from 1:1 (no compression) to ∞:1 (limiter).
 - 11 The 12-digit **GAIN REDUCTION** display (MDX4600: 8-digit) informs you about the current gain reduction applied (1 to 30 dB).
 - 12 The **LO CONTOUR** switch activates a high-pass filter in the side-chain path and thus avoids the “pumping” effect caused by high-energy bass frequencies and their influence on the compression process.
 - 13 Use the **ATTACK** control to determine when the compression sets in once the signal has exceeded threshold (MDX1600 and MDX2600 only). The setting range is from 0.3 to 300 ms.
 - 14 Press the **INTERACTIVE KNEE** switch to change from “hard knee” to IKA characteristic: Input signals exceeding threshold by up to 10 dB will be processed with a “soft knee” characteristic. Above 10 dB the control characteristic changes from “soft knee” to a more conventional “hard knee” compression. The IKA characteristic allows for a subtle and musical compression of the program material, and should be used whenever inaudible compression is desired.
 - 15 The **AUTO** function, which is activated with the **AUTO** switch, disables the **ATTACK** and **RELEASE** controls and derives these time values automatically from the program material. It thus allows for a heavy and, at the same time, musical compression of signals with varying levels or of complex program material.
 - 16 The **RELEASE** control (MDX1600 and MDX2600 only) sets the time when the original 1:1 gain is reached, after the signal has dropped below threshold again. The setting range is from 0.05 to 5 s.
 - 17 Use the **TUBE** switch (MDX2600 only) to enhance the output signal with the warm and transparent tonal character typically produced by electronic tubes.
 - 18 The **OUTPUT** control allows you to raise or lower the output signal by max. 20 dB, so as to make up for a gain loss caused by the compressor or limiter action. Raise the gain by roughly the same amount that it has been reduced by the compressor. The **GAIN REDUCTION** display [11] reads the value adjusted.
- When you adjust the **LIMITER** control in the peak limiter section, please note that the output gain of the compressor is set before the peak limiter. If the level is too high here, the peak limiter may respond permanently (see **LIMITER** control [29] in the peak limiter section).
- 19 The 12-digit **INPUT/OUTPUT LEVEL** display (MDX4600: 8-digit) reads both the level of the incoming audio signal and the level at the dynamics processor output. The range is from -30 to +18 dB (MDX4600: -24 to +18 dB).
 - 20 The **IN/OUT METER** switch selects whether the gain LEDs read the input signal (switch pressed) or the output signal (switch not pressed).
- This display is referenced to the operating level selected with the **OPERATING LEVEL** switch on the rear of the unit (-10 dBV or +4 dBu).
- 21 The **IN/OUT** switch activates the corresponding channel. It provides a so-called “hard bypass”, i.e. if it is OUT or the unit is not connected to the mains, the input jack will be linked directly to the output jack (COMPOSER PRO-XL MDX2600 only). Usually, this switch is used for direct A/B comparison between unprocessed and compressed/limited signals.

Application hints

Setting the compressor will be much easier if you first set both **limiter** and **expander** to a neutral setting by turning both threshold controls (TRIGGER and LIMITER) to OFF.

Setting the compression ratio requires your “sense of hearing”. Anything goes. In general, however, the ratio setting should not be too high for mix signals; instead, use 2:1 as a starting point to preserve the natural sound of the music; a ratio setting of about 4:1 has proved successful for vocal recordings. The IKA (Interactive Knee Adaptation) characteristic allows you to achieve a gradual and inaudible compression and hence to use higher ratios. If you want to use the compressor as an effect in its own right, don’t hesitate to experiment with higher values.

Turn the **THRESHOLD** control counter-clockwise until the **GAIN REDUCTION** display reads the desired gain reduction (don’t exceed 6 - 8 dB for mix signals). During this process the volume is reduced audibly. Now turn the **OUTPUT** control clockwise until this volume difference has been made up for. The levels of the compressed vs. uncompressed signals can be compared with the **INPUT/OUTPUT LEVEL** display activated with the I/O METER switch. These two levels should be the same.

The **AUTO** function for the attack and release times provides a program-dependent—and largely inaudible—dynamics control, which suits most standard applications. If a somewhat more “open” sound processing profile is required, you can set the attack and release times manually (AUTO switch not pressed).

Start with a longer **Release** time, then make it gradually shorter. You will soon notice an unnatural pumping effect caused by rapidly changing levels. Select a longer release time until the effect cannot be heard any longer.

The **Attack** time setting, too, is highly dependent on the music material. Select longer attack times for a subtle and musical compression. As a result you avoid attack portions of treble signals being cut off if compression is triggered by a high-level bass drum beat that is played at the same time. The sound remains transparent and compact throughout.

If the compressor is being used as a limiter, the attack time should be as short as possible. This, in combination with a high ratio (>20:1), a medium to long release time and the maximum possible threshold will protect your sound reinforcement system effectively from getting overloaded.

2.3 The dynamic enhancer section

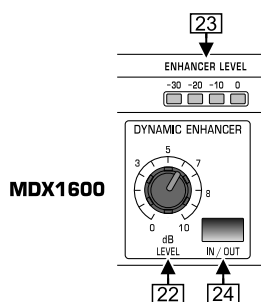

Fig. 2.4: Dynamic enhancer section control elements

The dynamic enhancer circuit implemented in all three dynamic processors allows you to dynamically enhance the treble range. Since the bass portions of a music signal often have the highest energy yield, they usually are the ones that trigger the compression process, thus also reducing the gain of middle to high frequencies. The enhancer controls the compression process and gradually adds more highs, the stronger the treble range is compressed, so as to make up for the subjective loss of high-frequency content.

[22] LEVEL control (MDX1600). The AUTOCOM PRO-XL features an adjustable enhancer, on which you can set the amount of treble boost with the **LEVEL** control.

ENHANCER switch (MDX2600 and MDX4600). Activates the dynamic enhancer.

[23] ENHANCER LEVEL. The LED chain reads the current treble boost within a range from -30 to 0 dB (MDX1600 only).

[24] IN/OUT switch (MDX1600). Use this switch to activate the enhancer circuit, e.g. to assess the effect the enhancer has on the audio signal.

2.4 The de-esser section

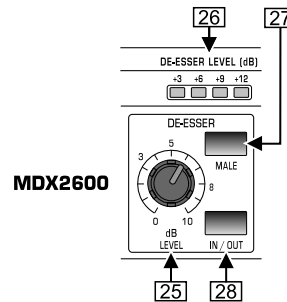

Fig. 2.5: De-esser section control elements

From a circuitry point of view, the de-esser is placed in the side-chain path of the compressor, so it will operate only if the compressor is active.

[25] LEVEL control (MDX2600). Instead of an adjustable enhancer, the COMPOSER PRO-XL has a controllable de-esser, which helps you eliminate hiss noise contained in the audio signal. The **LEVEL** control determines the amount of frequency suppression.

DE-ESSER switch (MDX1600). The AUTOCOM PRO-XL also has a de-esser. At the touch of a button you can enhance the audio signal considerably, especially when processing vocal recordings. Switch **[25]** can be found in the compressor section.

[26] DE-ESSER LEVEL (MDX2600). The LED chain reads the current attenuation within a range from +3 to +12 dB.

[27] MALE switch. This switch adapts the de-esser to the male (switch pressed) or female registers (not pressed).

[28] IN/OUT switch. Switches the de-esser on and off.

2.5 The peak limiter section

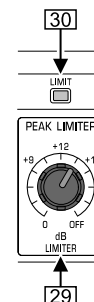

Fig. 2.6: Peak limiter section control elements

[29] The peak limiter limits the signal to an adjustable level. When the **LIMITER** control is turned fully to the right, the limiter is switched off. Owing to its extremely fast “zero” attack, this circuit is capable of limiting signal peaks without any overshoot. If the signal is limited for more than 20 ms, the overall gain is reduced for about 1 s to avoid strong and thus audible limiter effects.

If you wish to use the peak limiter as a protecting device, the **LIMITER** control and the **OUTPUT** control in the compressor section should be set so that the peak limiter responds only rarely or never at all. It should be triggered by peak signals only. To achieve creative sound effects, on the other hand, you can also intentionally drive the peak limiter into this peak limiting range.

[30] The **LIMIT** LED lights up as soon as the limiter is on.

2.6 The rear panel control elements

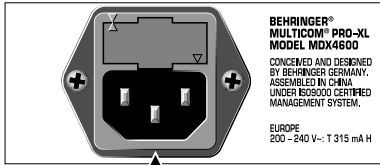

Fig. 2.7: Power supply and fuse

[31] **FUSE HOLDER/VOLTAGE SELECTOR.** Before connecting the unit to the mains, ensure that the voltage setting matches your local voltage. A blown fuse should only be replaced by a fuse of the same type and rating. Please refer to chapter 6 "SPECIFICATIONS" for details.

MAINS CONNECTION. Use the power cord supplied with the unit to connect it to the mains. Please note the instructions given in chapter 5 "INSTALLATION".

[32] **OUTPUTS.** These are the audio outputs of your dynamics processor. The two matching 1/4" TRS and XLR connectors are wired in parallel and balanced. Of course, unbalanced cables can be connected here as well.

[33] **OPERATING LEVEL** switch. This switch can be used to adapt the **COMPOSER PRO-XL**, **AUTOCOM PRO-XL** or **MULTICOM PRO-XL** to various operating levels, i.e. to toggle between home recording level (-10 dBV) and studio level (+4 dBu). The level meters will be referenced automatically to the nominal level adjusted, so that the compressor works in its optimum operating range.

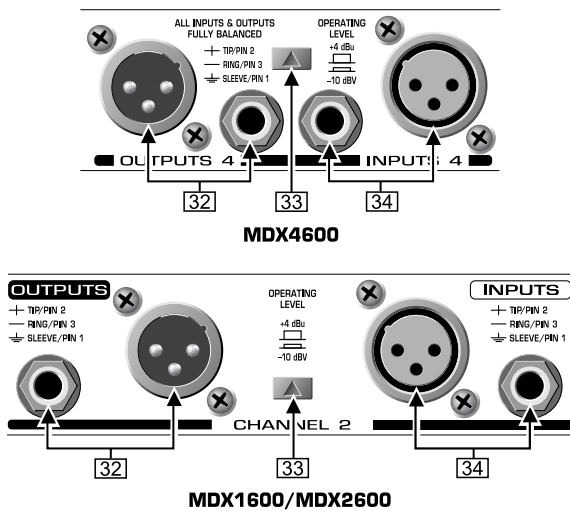

Fig. 2.8: Rear panel connectors and switches

[34] **INPUTS.** These are the audio inputs. They are also on balanced 1/4" TRS and XLR connectors.

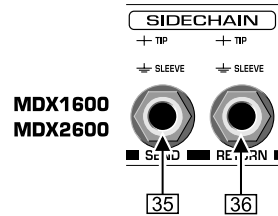

Fig. 2.9: SIDECHAIN connectors

[35] **SIDECHAIN SEND.** This is the unbalanced sidechain output, which allows you to route the audio signal to other devices for external processing.

[36] **SIDECHAIN RETURN.** The sidechain input allows you to use an external signal or the processed (e.g. with an equalizer) audio signal routed from the SIDECHAIN SEND jack to control your **COMPOSER PRO-XL** or **AUTOCOM PRO-XL**.

3. EXAMPLES OF SIDECHAIN APPLICATIONS

A very common type of application is to make the compressor threshold frequency-dependent by inserting a graphic or parametric equalizer into the side-chain path. To be able to keep the threshold setting on the MDX1600 or MDX2600, unwanted frequencies should be cut with an inserted equalizer, without affecting the levels of selected frequencies. For example, to control the compressor from a narrow-band midrange frequency band, we recommend reducing the bass and treble controls on the inserted EQ, while leaving the midrange control set to 0 dB.

3.1 Eliminating interference

Insert an equalizer into the sidechain control path in the following order: **SIDECHAIN SEND** - equalizer - **SIDECHAIN RETURN**. Turn the **THRESHOLD** control to the left until the **GAIN REDUCTION** meter reads a clearly noticeable gain reduction. Now the equalizer must be set so that all frequencies are reduced in level, except for the interference frequencies. Thus, the interference signal will trigger the compression.

Using this technique you can, for example, reduce the dynamics of a bass drum that is too loud in an existing recording. Simply use an equalizer to cut all frequencies above 150 Hz, so that the compression will be triggered by the individual beats of the bass drum.

To monitor the equalizer setting, press the **SC MON** switch to isolate and play back the processed signal.

Once you have checked the EQ setting, switch off **SC MON** and adjust the **THRESHOLD**, so that the compressor responds to the interference signals only.

Control element	Position
SC EXT switch	IN
SC MON switch	OUT
INTERACT KNEE switch	OFF
LO CONTOUR switch	OUT
THRESHOLD control	+20 dB
RATIO control	4:1
AUTO switch	OUT
ATTACK control	0.3 msec
RELEASE control	150 msec
OUTPUT control	0 dB

Tab. 3.1: Eliminating interference with an inserted equalizer (basic settings)

3.2 Emphasizing instruments

Conversely, you can also use your COMPOSER PRO-XL or AUTOCOM PRO-XL to highlight solo instruments or vocal tracks acoustically in a less than perfect recording.

Please note that in this application only the amplitudes of the selected frequencies should be reduced in level.

Compression produces a subjective volume reduction of the entire program material. Only those frequencies selected on the equalizer will cause NO compression and thus they seem to be emphasized acoustically. This inverse type of compression helps you make instruments stand out even in low-level passages.

3.3 Time-delayed compression

If you feed the audio signal directly into the SC RETURN input and at the same time route it to the audio input via a delay unit, the dynamics processor will work "anticipatorily". With a bit of tweaking you can achieve "zero" attack effects for specific frequencies. Longer delays produce an effect that is similar to an audio tape being played back in reverse.

3.4 "Voice over" compression ("ducking")

You can use the COMPOSER PRO-XL and AUTOCOM PRO-XL to lower music to a low background level as soon as a speaker speaks into the microphone. In this type of application the compressor section functions like an automatic fader controlled by the speaker's microphone, which is also connected to the SC RETURN input via a preamplifier. Music and microphone signal are then mixed with the help of a console. This application is called "voice over" compression or "ducking", and is used frequently in discotheques or radio stations.

3.5 Triggering additional sounds from a rhythm track

This technique is used to give a rhythm track more "punch" by synchronizing the rhythm instruments after recording. Only the expander/gate section is required, the compressor and/or peak limiter remain disabled. Insert the bass guitar track into the audio path of the COMPOSER PRO-XL (or AUTOCOM PRO-XL), and route the bass drum to the SC RETURN input. Activate the SC EXT function to trigger the bass guitar with the kick drum, i.e. the kick drum exceeds the expander threshold, allowing the bass guitar signal to pass until the level has dropped below threshold again.

4. WIRING

Dynamics processors are usually inserted into the insert paths of a mixing console, because their signals are not added to the mix (unlike reverb or phaser effects, which are fed into the signal path via the aux busses).

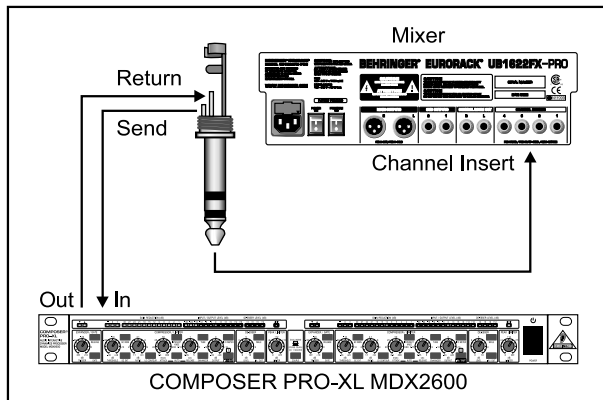

Fig. 4.1: Inserting a dynamics processor into the insert path

You can also insert the COMPOSER PRO-XL, MULTICOM PRO-XL or AUTOCOM PRO-XL into a sub-group insert (miking of drums!) or to process the mix output of the console (Main Out and/or Main Inserts). Here, too, the processor should be inserted into an insert path, so that you can fade out the overall signal by closing the main faders on the console.

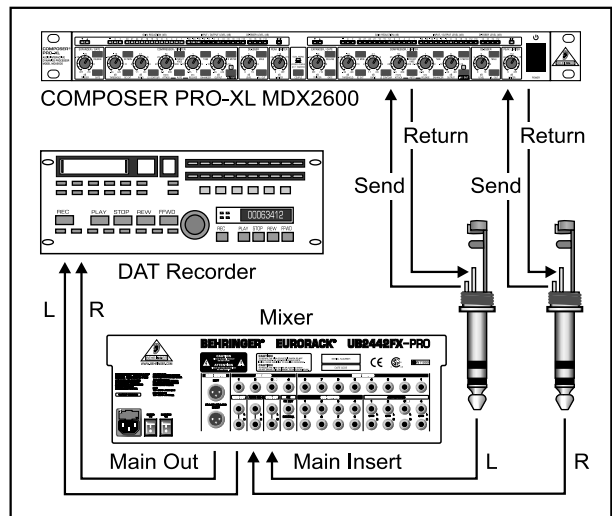

Fig. 4.2: Compressing a main mix signal with the MDX2600

When you process a stereo mix signal, we recommend that you link the channels in couple mode, because there is no faster and easier way to find the right settings. However, remember to set the output levels separately!

If you wish to use the dynamics processor as part of a P.A. system integrating an active frequency crossover (e.g. BEHRINGER SUPER-X PRO CX2310), you can connect it between the mixing console output and the crossover input, or between the crossover and the power amps. In the latter configuration you can process individual frequency ranges specifically (multi-band compression) to prevent a few high-energy frequencies triggering the compressor to process the entire frequency range. The illustration below shows how to set up this configuration with the BEHRINGER MULTICOM PRO-XL MDX4600.

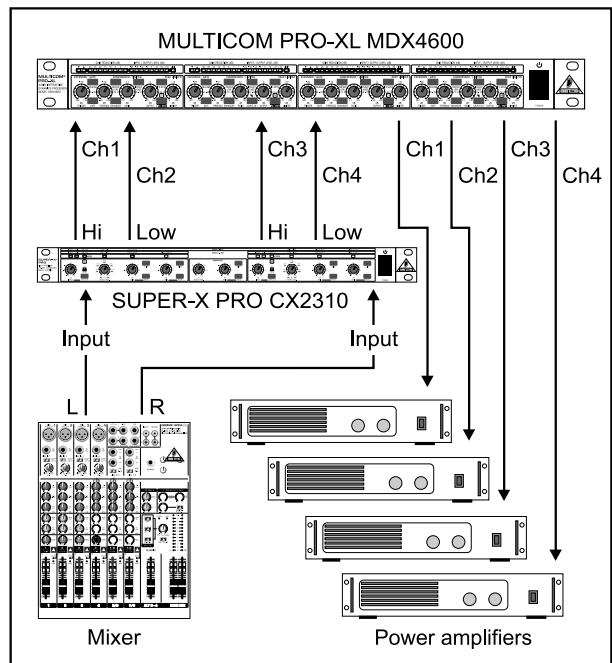

Fig. 4.3: Multi-band compression with the MDX4600

5. INSTALLATION

5.1 Rack installation

Each device requires one rack unit for installation in a 19" rack. Please allow an additional 4" of rack depth for the rear panel connectors.

Be sure that there is enough air space around the unit for cooling. To avoid overheating, do not place the unit on power amps, for example.

5.2 Audio connections

You will need a large number of cables for the different applications. The illustrations below show the wiring of these cables. Be sure to use only high-grade cables.

The audio connections of the MULTICOM PRO-XL, AUTOCOM PRO-XL and COMPOSER PRO-XL are electronically balanced to avoid hum problems.

You can, of course, also connect unbalanced devices to the balanced inputs/outputs. Either use mono plugs, or link the ring and shaft on stereo plugs (or pins 1 and 3 in the case of XLR connectors).

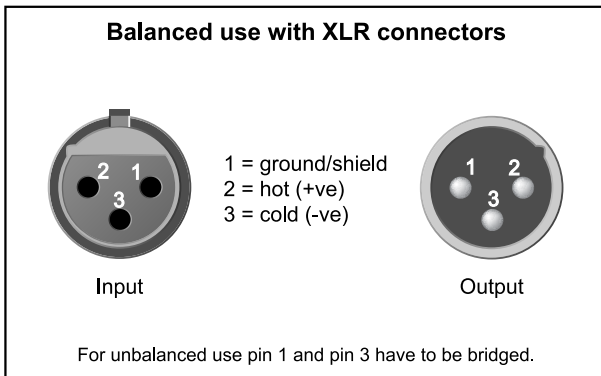

Fig. 5.1: XLR connections

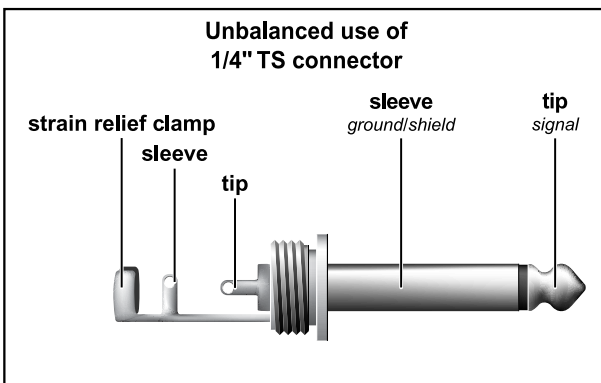

Fig. 5.2: 1/4" TS connector

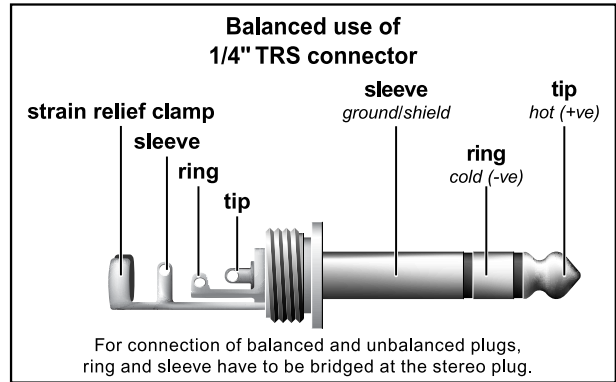

Fig. 5.3: 1/4" TRS connector

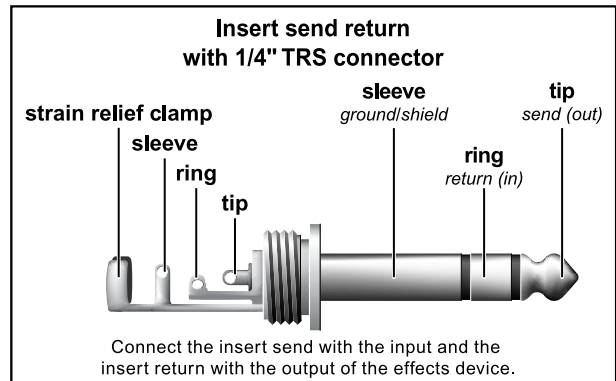

Fig. 5.4: 1/4" TRS connector for insert applications

6. SPECIFICATIONS

AUDIO INPUTS

Type	XLR and 1/4" TRS connectors, HF-shielded, servo-balanced
Impedance	90 kΩ bal., 45 kΩ unbal. @ 1 kHz
+4 dBu	180 kΩ bal., 90 kΩ unbal. @ 1 kHz
-10 dBV	+4 dBu/-10 dBV (switchable)
Operating level	+22 dBu balanced and unbalanced
Max. input level	typ. 40 dB, >60 dB @ 1 kHz

AUDIO OUTPUTS

Type	XLR and 1/4" TRS connectors Electronically controlled servo-balanced output stage
Impedance	95 Ω bal., 50 Ω unbal. @ 1 kHz
Max. output level	+21 dBu, +20 dBm balanced and unbalanced

SIDCHAIN INPUTS

Type	1/4" TS connector, unbalanced, HF-shielded, DC-decoupled
Impedance	45 kΩ
Max. input level	+24 dBu

SIDCHAIN OUTPUTS

Type	1/4" TS connector, unbalanced, HF-shielded, DC-decoupled
Impedance	50 Ω
Max. output level	+21 dBu

SYSTEM SPECIFICATIONS

Bandwidth	20 Hz to 20 kHz, +0/-0.5 dB
Frequency range	0.35 Hz to 200 kHz, +0/-3 dB
S/N ratio	115 dB, unweighted, 22 Hz - 22 kHz
THD	0.008 % typ. @ +4 dBu, 1 kHz, gain 1 0.07 % typ. @ +20 dBu, 1 kHz, gain 1
IMD	0.01 % typ. SMPTE
Crosstalk	-110 dB @ 1 kHz

EXPANDER/GATE SECTION

Type	IRC (Interactive Ratio Control) expander
Threshold	variable (OFF to +10 dB)
Ratio	variable (1:1 to 1:8)
Attack	<1 msec/50 dB, program-dependent
Release	variable SLOW: 100 msec/1 dB, FAST: 100 msec/100 dB

COMPRESSOR SECTION

Type	IKA (Interactive Knee Adaptation) compressor
Threshold	variable (-40 to +20 dB)
Ratio	variable (1:1 to ∞:1)
Attack/release	variable (manual or automatic)
Auto characteristic	wave adaptive compressor
Manual attack time	variable (0.3 msec/20 dB to 300 msec/20 dB)
Manual release time	variable (0.05 sec/20 dB to 5 sec/20 dB)
Auto attack time	typ. 15 msec for 10 dB, 5 msec for 20 dB, 3 msec for 30 dB
Auto release time	program-dependent, typ. 125 dB/sec
Output	variable (-20 to +20 dB)

PEAK LIMITER SECTION

Type	IGC (Interactive Gain Control) peak limiter
Level	variable (0 dB to OFF (+21 dBu))
Ratio	∞:1
Level 1 limiter type	clipper
Attack	"zero"
Release	"zero"
Level 2 limiter type	program limiter
Attack	program-dependent, typ. <5 msec
Release	program-dependent, typ. 20 dB/sec

DE-ESSER SECTION

Type	VAD (Voice-Adaptive De-esser)
MDX1600	
Filter frequency	5-8 kHz
Filter bandwidth	program-dependent
Level reduction	max. 15 dB
MDX2600	
Filter frequencies	8.6 kHz (female), 7.5 kHz (male)
Filter bandwidth	program-dependent
Level reduction	variable, max. 15 dB

DYNAMIC ENHANCER SECTION

Type	IDE (Interactive Dynamic Enhancer)
MDX1600	
Filter frequency	2.5 kHz (lower cut-off frequency)
Characteristic	high-pass filter (6 dB/oct.)
Boost	variable, max. 40 dB @ 7.5 kHz
MDX2600	
Filter frequency	2.5 kHz (lower cut-off frequency)
Characteristic	high-pass filter (6 dB/oct.)
Boost	max. 28 dB @ 7.5 kHz
MDX4600	
Filter frequency	2.5 kHz (lower cut-off frequency)
Characteristic	high-pass filter (6 dB/oct.)
Boost	max. 28 dB @ 7.5 kHz

POWER SUPPLY

Mains voltage	USA/Canada 120 V ~, 60 Hz U.K./Australia 240 V ~, 50 Hz Europe 230 V ~, 50 Hz
General export model	100 -120 V ~, 200 -240 V ~, 50 - 60 Hz
Power consumption	
MDX1600/MDX2600	max. 15 W
MDX4600	max. 18 W
Fuse	
MDX1600/MDX2600	100 -120 V ~: T 250 mA H 200 -240 V ~: T 125 mA H
MDX4600	100 -120 V ~: T 630 mA H 200 -240 V ~: T 315 mA H
Mains connection	standard IEC receptacle

DIMENSIONS/WEIGHT

Dimensions	approx. 1 3/4" (44.5 mm) x 19" (482.6 mm) x 8 1/2" (217 mm)
MDX1600	
Weight	approx. 2.1 kg
Shipping weight	approx. 3.3 kg
MDX2600	
Weight	approx. 2.1 kg
Shipping weight	approx. 3.3 kg
MDX4600	
Weight	approx. 2.25 kg
Shipping weight	approx. 3.45 kg

BEHRINGER makes every effort to ensure the highest standard of quality. Necessary modifications are carried out without notice. Thus, the specifications and design of the device may differ from the information given in this manual.

7. WARRANTY

§ 1 WARRANTY CARD/ONLINE REGISTRATION

To be protected by the extended warranty, the buyer must complete and return the enclosed warranty card within 14 days of the date of purchase to BEHRINGER Spezielle Studiotechnik GmbH, in accordance with the conditions stipulated in § 3. Failure to return the card in due time (date as per postmark) will void any extended warranty claims. Based on the conditions herein, the buyer may also choose to use the online registration option via the Internet (www.behringer.com or www.behringer.de).

§ 2 WARRANTY

1. BEHRINGER (BEHRINGER Spezielle Studiotechnik GmbH including all BEHRINGER subsidiaries listed on the enclosed page, except BEHRINGER Japan) warrants the mechanical and electronic components of this product to be free of defects in material and workmanship for a period of one (1) year* from the original date of purchase, in accordance with the warranty regulations described below. If the product shows any defects within the specified warranty period that are not excluded from this warranty as described under § 3 and 4, BEHRINGER shall, at its discretion, either replace or repair the product using suitable new or reconditioned parts. In the case that other parts are used which constitute an improvement, BEHRINGER may, at its discretion, charge the customer for the additional cost of these parts.

2. If the warranty claim proves to be justified, the product will be returned to the user freight prepaid.

3. Warranty claims other than those indicated above are expressly excluded.

§ 3 RETURN AUTHORIZATION NUMBER

1. To obtain warranty service, the buyer (or his authorized dealer) must call BEHRINGER (see enclosed list) during normal business hours **BEFORE** returning the product. All inquiries must be accompanied by a description of the problem. BEHRINGER will then issue a return authorization number.

2. Subsequently, the product must be returned in its original shipping carton, together with the return authorization number to the address indicated by BEHRINGER.

3. Shipments without freight prepaid will not be accepted.

§ 4 WARRANTY REGULATIONS

1. Warranty services will be furnished only if the product is accompanied by a copy of the original retail dealer's invoice. Any product deemed eligible for repair or replacement by BEHRINGER under the terms of this warranty will be repaired or replaced within 30 days of receipt of the product at BEHRINGER.

2. If the product needs to be modified or adapted in order to comply with applicable technical or safety standards on a national or local level, in any country which is not the country for which the product was originally developed and manufactured, this modification/adaptation shall not be considered a defect in materials or workmanship. The warranty does not cover any such modification/adaptation, irrespective of whether it was carried out properly or not. Under the terms of this warranty, BEHRINGER shall not be held responsible for any cost resulting from such a modification/adaptation.

3. Free inspections and maintenance/repair work are expressly excluded from this warranty, in particular, if caused by improper handling of the product by the user. This also applies to defects caused by normal wear and tear, in particular, of faders, potentiometers, keys/buttons and similar parts.

4. Damages/defects caused by the following conditions are not covered by this warranty:

▲ improper handling, neglect or failure to operate the unit in compliance with the instructions given in BEHRINGER user or service manuals.

▲ connection or operation of the unit in any way that does not comply with the technical or safety regulations applicable in the country where the product is used.

▲ damages/defects caused by force majeure or any other condition that is beyond the control of BEHRINGER.

5. Any repair or opening of the unit carried out by unauthorized personnel (user included) will void the warranty.

6. If an inspection of the product by BEHRINGER shows that the defect in question is not covered by the warranty, the inspection costs are payable by the customer.

7. Products which do not meet the terms of this warranty will be repaired exclusively at the buyer's expense. BEHRINGER will inform the buyer of any such circumstance. If the buyer fails to submit a written repair order within 6 weeks after notification, BEHRINGER will return the unit C.O.D. with a separate invoice for freight and packing. Such costs will also be invoiced separately when the buyer has sent in a written repair order.

§ 5 WARRANTY TRANSFERABILITY

This warranty is extended exclusively to the original buyer (customer of retail dealer) and is not transferable to anyone who may subsequently purchase this product. No other person (retail dealer, etc.) shall be entitled to give any warranty promise on behalf of BEHRINGER.

§ 6 CLAIM FOR DAMAGES

Failure of BEHRINGER to provide proper warranty service shall not entitle the buyer to claim (consequential) damages. In no event shall the liability of BEHRINGER exceed the invoiced value of the product.

§ 7 OTHER WARRANTY RIGHTS AND NATIONAL LAW

1. This warranty does not exclude or limit the buyer's statutory rights provided by national law, in particular, any such rights against the seller that arise from a legally effective purchase contract.

2. The warranty regulations mentioned herein are applicable unless they constitute an infringement of national warranty law.

* Customers in the European Union please contact BEHRINGER Germany Support for further details.

The information contained in this manual is subject to change without notice. No part of this manual may be reproduced or transmitted in any form or by any means, electronic or mechanical, including photocopying and recording of any kind, for any purpose, without the express written permission of BEHRINGER Spezielle Studiotechnik GmbH.

BEHRINGER, COMPOSER, AUTOCOM, MULTICOM, SUPER-X and EURORACK are registered trademarks.

ALL RIGHTS RESERVED. © 2002 BEHRINGER Spezielle Studiotechnik GmbH.

BEHRINGER Spezielle Studiotechnik GmbH, Hanns-Martin-Schleyer-Str. 36-38, 47877 Willich-Münchheide II, Germany

Tel. +49 (0) 21 54 / 92 06-0, Fax +49 (0) 21 54 / 92 06-30